

Compact Class

SUPER 1003

WHEELED PAVER



Maximum pave width 3.9m
Maximum laydown rate 230 tonnes/h
Transport width 1.85m

CLASSIC
LINE

 www.voegele.info



Compact and manoeuvrable - The small wheeled paver



The SUPER 1003 has been designed as a highly cost-efficient and compact wheeled paver. Wherever a job involves building minor roads or surfacing small areas, this VÖGELE paver is the ideal choice. What is more, confined spaces at a job site are no problem, because, with its extremely compact dimensions, this paver is totally manoeuvrable even in the tightest spots.

As a VÖGELE Classic Line paver, it has a very solid range of basic features, the most striking being the ErgoBasic operating system. This system was developed on the basis of the tried-and-tested ErgoPlus 3 operating system and specially tailored to the needs of Classic Line machine users.

As with ErgoPlus 3, the design of the paver operator's ErgoBasic console is so clear that all functions can be grasped quickly and operated securely.

The SUPER 1003 combines with the AB 340 Extending Screed in the V and TV versions. It goes without saying that, like all VÖGELE screeds, this one also offers electric screed heating and achieves a high degree of precompaction.

Highlights of the SUPER 1003



Wheeled Compact Class paver with a wide range of applications and pave widths up to 3.9m

Powerful and economical drive concept, even when operating at full load and in any climate zone

Simple operation thanks to the innovative and easy-to-grasp ErgoBasic operating concept

Significantly smaller turning radius due to Pivot Steer steering brake

Can be combined with the AB 340 TV Extending Screed in the V and TV versions

Compact dimensions for paving in very tight spaces



Small size, high efficiency: be it extremely confined job sites outside of town or winding inner-city alleyways, the highly manoeuvrable VÖGELE Compact Class pavers can negotiate tight spots with ease while delivering top performances.



» **The slim paver design,** with no protruding edges and a compact overall length, makes it very easy to work and manoeuvre on tight job sites.

» **The clearance width** of just 1.85m allows the SUPER 1003 to easily get in and out of confined spaces such as narrow alleys. The push-rollers automatically fold up together with the hopper sides.

» **For transport,** the hardtop, made of a glass fibre-reinforced polymer material, and the exhaust pipe can be folded down in just a few swift moves, readying the paver for transport quickly and easily.



Range of applications of the VÖGELE Compact Class

With their combination of compact dimensions and top performance, road pavers in the VÖGELE Compact Class can handle a wide variety of applications.

Whether it is a combined footpath and cycle path, a farm track or minor roads and small areas, the SUPER 1003 is more than up to the task, thanks to its wide range of pave widths from 0.75m to 3.9m and its innovative drive concept.



PAVEMENT REHABILITATION ON MUNICIPAL ROADS



REHABILITATING ACCESS ROADS

The applications illustrated here are typical of the VÖGELE Compact Class.

The drive concept - Efficiency, performance and low consumption



VÖGELE's modern drive concept guarantees full power whenever it is needed. Superior technology also makes this Compact Class paver exceedingly economical in everyday

use thanks to the intelligent engine management with ECO mode and variable-speed fan. These features significantly reduce the SUPER 1003's fuel consumption and noise emissions.

The high-traction wheeled undercarriage on the SUPER 1003 paver perfectly combines high performance paving with maximum mobility during transport.

Modern drive technology

Three main components form the power unit of the SUPER 1003: the large cooler assembly, an advanced, liquid-cooled diesel engine and a splitter gearbox flanged directly to the engine.

The driving force behind this VÖGELE powerhouse is a powerful diesel engine. The 4-cylinder engine delivers 55kW at 2,000rpm. Yet the fuel-saving ECO mode is sufficient for many applications. And even then, the SUPER 1003 still has a full 54kW at its disposal. Moreover, the machine operates particularly quietly when running at just 1,600rpm.

A large cooler assembly ensures that the power unit always delivers its full output. With innovative air routing and a variable-speed fan, temperatures

are always maintained within the optimum range, significantly extending the service life of both the diesel engine and the hydraulic oil. Another advantage is that the machine can be operated without difficulty in all climatic regions around the world.

All hydraulic consumers are directly supplied with hydraulic oil via the splitter gearbox. Hydraulic pumps and valves are centrally located, making them optimally accessible for servicing.

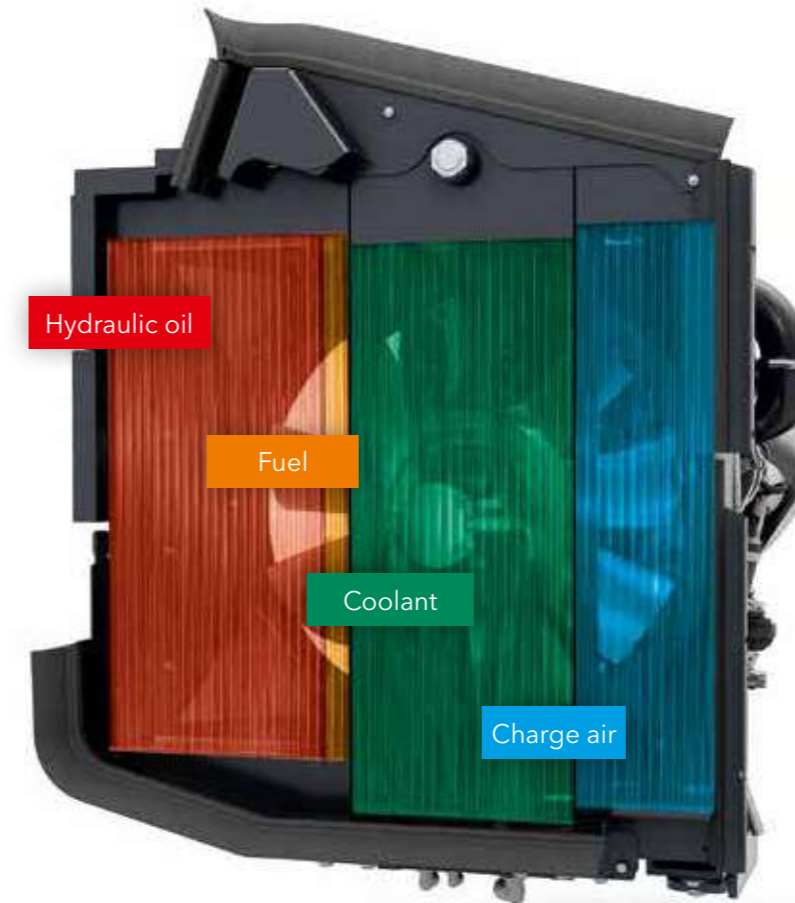

The large cooler assembly is made up of four parts. It ensures that charge air, engine coolant, fuel and hydraulic oil are maintained at optimum temperature.

- » **Powerful diesel engine** develops 55kW at just 2,000rpm.
- » **ECO mode**, which delivers 54kW at 1,600rpm, is not only perfectly adequate for many applications, it also cuts operating costs and supports super-quiet operation.

- » **A powerful three-phase A.C. generator** with generator management controls output in line with the selected pave width and minimizes the time required to heat the compacting systems up to operating temperature.



Mobility on wheels

The high-traction SUPER 1003 wheeled paver perfectly combines high performance paving with maximum mobility during transport, thanks to powerful separate hydraulic drives integrated in the powered wheels. They provide for maximum traction.



» **Rapid transport under its own power** at up to 20km/h - a feat the SUPER 1003 is optimally equipped for. The paver can optionally be equipped with a lighting system approved for use in traffic. As a result, this machine meets the basic requirement for driving on public roads.

» **Maximum power transmission** thanks to separate, hydraulic drives in both rear wheels and optionally in two front wheels.

» **Optimum traction** is assured, even on difficult terrain, by Electronic Traction Management and an electronic limited slip differential acting on the drives of the rear wheels.

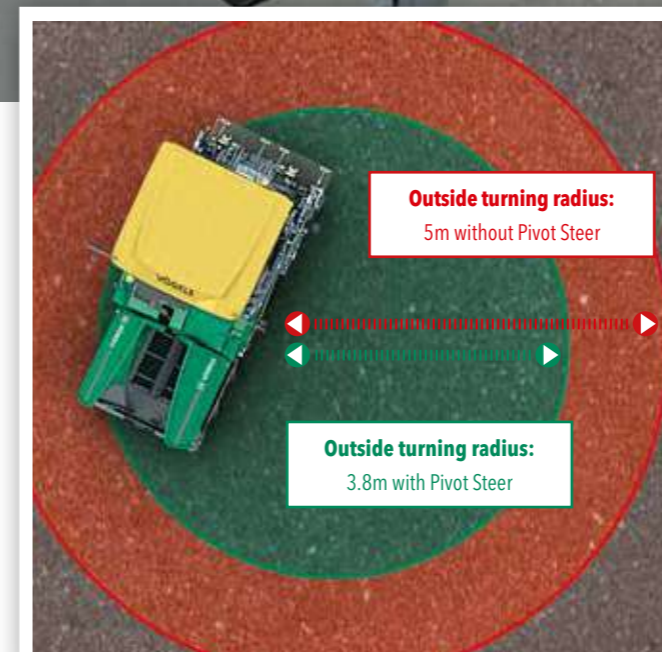

Highly manoeuvrable thanks to Pivot Steer. With Pivot Steer activated, the rear inside wheel is automatically slowed down hydraulically. This minimizes the outside turning radius to no more than 3.8m for positioning manoeuvres and paving. The function can be activated in "Pave" and "Positioning" modes, greatly increasing the manoeuvrability of the machine on confined job sites.

Top-quality paving thanks to perfect material management



A continuous flow of mix is key to ensuring uninterrupted and high-quality paving. That is why we attach such importance to professional material management when designing our pavers.

All our development efforts focus on simple operation and the best possible overview for the paving team.

Easy and clean feeding with mix

Despite the paver's slim profile, its material hopper holds 10t. The paver comes with oscillating push-rollers to ensure the shock-free docking of feed vehicles.

Separately folding hopper sides ensure smooth feeding with mix even when paving across asymmetrical widths and a convenient mix supply even when paving along boundaries.



- » **Oscillating push-rollers** for convenient and shock-free docking also of large feed vehicles.
- » **The large material hopper** has a capacity of 10t so that a sufficient quantity of mix is available for paving at all times, even in situations where feeding is difficult, such as when paving under bridges.
- » **Separately folding hydraulic hopper sides** for smooth feeding with mix, paving along boundaries and a targeted mix supply even when paving across asymmetrical widths.

Perfect conveying and spreading of mix, just like the big pavers

The conveyance and even spreading of mix in front of the screed are optimal thanks to the large conveyor tunnel, proportional control of conveyors and powerful augers.

What is more, the height-adjustable augers and folding limiting plates for the auger tunnel allow the paver to be repositioned without a need for conversion, a benefit that saves time and money.

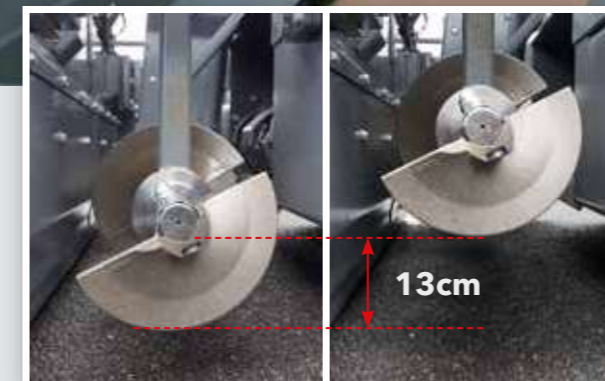

The height of the augers is infinitely variable by 13cm for uniform spreading of mix across the entire pave width.

- » **The amply dimensioned conveyor tunnel** and powerful, separate hydraulic drives for conveyors and augers support laydown rates of up to 230t/h, which are extraordinarily high for a paver in this class.
- » **Separate drives and controls** are installed for each conveyor and auger. When operating in Automatic mode, conveyors and augers are subject to continual monitoring. Proportional control provides for a constant head of mix in front of the screed.

The new ErgoBasic operating concept



The **ErgoBasic operating concept** was developed on the basis of the proven ErgoPlus operating system which is installed in our Premium Line pavers, but was tailored specifically to the needs and requirements of VÖGELE Classic Line users.

The goal was to develop an operating system that can be operated just as quickly, accurately and intuitively as the ErgoPlus 3 system on the "Dash 3" machines.

This makes VÖGELE the only manufacturer to offer a standardized operating concept for all paver classes.



The paver operator's **ErgoBasic** console

“Full control for the machine operator!”

The paver operator's ErgoBasic console

Everything at a glance: the functions are arranged in a clear, logical and practical layout that has clearly been inspired by the ErgoPlus operating console. The type of controls and the symbols used are all in line with those on an ErgoPlus console. Given the limited number of functions, there is no need for a display.

The status of all settings is indicated as a percentage on LED strips immediately next to the relevant functions.

Additional LEDs indicate the set speeds of the augers and the compacting systems as well as the fill level of the diesel tank.

Pivot Steer steering brake

The Pivot Steer steering brake can be switched on with a simple push of a button in the "Positioning" and "Pave" modes. When it is activated, the speed of the rear inside wheel is automatically slowed down hydraulically at the maximum steering angle. This reduces the turning radius to a minimum.



Function and status indicators

The function and status indicators mean that the operator always has full control over his machine. He can, for instance, read the fill level of the fuel tank directly and identify whether there are any functional faults.



Choice of operating modes for the paver

All the main paving and machine functions can be controlled directly by individual push-buttons on the paver operator's ErgoBasic console. The paver changes between operating modes at the push of a button in the following order: "Pave", "Positioning", "Job Site" and "Neutral". An LED indicates which mode is selected. On leaving "Pave" mode, the memory function stores all the most recent settings. After moving on the job site, the previously used paving parameters are instantly restored.



Speed of the augers

In Automatic mode, the plus/minus buttons can be used to adjust the maximum auger speed separately for the right and left sides to suit the pave width, without the use of sonic sensors. The value, which is set in percent, is indicated by the LEDs.





Lighting for travelling on public roads

The SUPER 1003 can be equipped with a lighting system approved throughout Europe for use on public roads. The push-buttons for the direction indicators, warning lights, dipped beams and full beams are clearly arranged side-by-side on the console.



Compacting effort

The speed of the compacting systems can be set directly on the paver operator's ErgoBasic console. The LED strips from 0 to 100% indicate the speed settings for the tamper and vibrators, enabling them to be adjusted immediately if required.



No-load function

The no-load function is provided for the warm-up or cleaning of conveyors, augers and tamper.



Safe operation during the night

The paver operator's ErgoBasic console features glare-free backlighting so that the paver operator can also work safely on night-time jobs.



The **ErgoBasic** remote control unit for the screed

The **safe and easy handling** of all screed functions is a key factor in high-quality pavement construction. That's why an ErgoBasic remote control unit for the screed was developed specifically for the new Classic Line pavers.

Its keypad is laid out logically according to the functional processes. Designed for robustness, it is well able to withstand tough job-site conditions.

Operation is easy to understand and can be learned intuitively in a very short space of time, not least because the symbols used in the proven ErgoPlus operating system are found here, too.

The ErgoBasic remote control unit for the screed allows all paving-related functions to be set quickly and easily. This includes direct access to the material handling systems and the sonic sensors for the augers.

All the main paving functions can be controlled using the two handy remote control units for the screed. Simple, language-neutral symbols allow the machine to be operated intuitively.



- 1 // **Conveyor setting**
automatic/manual
- 2 // **Horn**
- 3 // **Auger setting**
automatic/manual/reverse
- 4 // **Screed floating** on/off
- 5 // **Adjustment of screed width**
one side
- 6 // **Adjustment of screed tow point ram**



The operator's Niveltronic Basic console

VÖGELE have also developed a System for Automated Grade and Slope Control to match the ErgoBasic operating concept: the Niveltronic Basic. It is completely integrated into the machine control system and therefore perfectly adapted to the respective paver model. Another outstanding aspect of Niveltronic Basic is its particularly simple and intuitive handling, a feature which makes it easy even for less experienced operators to learn their way around the system. This creates ideal conditions for the Classic Line pavers to work true to line and level on any base.

Each side of the screed is operated by a separate compact and exceedingly robust Niveltronic Basic remote control unit.

A variety of sensor types is available for Niveltronic Basic, in keeping with the machine's large and varied range of uses. The selection extends from mechanical sensors to non-contacting sonic sensors. The System for Automated Grade and Slope Control can simultaneously be connected to two grade sensors and one slope sensor. The type of sensor used is detected automatically.

The kind of reference - ground, tensioned wire or transverse slope - can be easily set on the remote control unit.

The remote control units cover all the functions required for high-precision grade and slope control. Clear symbols support intuitive machine operation.



- 1 // **Deviation** from specified values
- 2 // **Niveltronic Basic** on/off
- 3 // **Setting** for sensor sensitivity
- 4 // **Selection of scanning mode** for the sensor (ground/tensioned wire/transverse slope)
- 5 // **Quick set-up**
- 6 // **Setting** of the specified value
- 7 // **Sensor calibration**





Paver operator's ErgoBasic platform

1. The comfortable paver operator's platform

gives an unobstructed view of all crucial areas on the paver such as material hopper, steering guide or screed. The paver operator is thus ideally positioned to monitor the material feeding process right from his seat.

2. Working comfortably

The operating console can be shifted across the entire working width so that operators can work comfortably and in an ergonomic position on either side of the machine.

3. A place for everything and everything in its place

The paver operator's platform is streamlined and well organized, offering the paver operator a professional workplace. The paver operator's console can be protected by a shatter-proof cover to prevent wilful damage.

4. Hardtop provides excellent protection

The modern hardtop, made of a glass fibre-reinforced polymer material, protects the operator. It can easily be collapsed to quickly prepare the paver for transport.

5. Cost-efficient and service-friendly design

The paver operator has convenient access to all service points on the machine. All hydraulic pumps connected to the transfer gearbox are extremely easy to service thanks to their clear arrangement and easy accessibility. Durable components made of highly wear-resistant materials for a long service life minimize machine downtimes.

6. Safe and comfortable ascent

The walkway and comfortable middle ascent on the screed ensure safe and convenient access to the paver operator's platform.

7. Safe and simple operation of all screed functions

All paving-related functions can be set quickly and easily on the ErgoBasic remote control unit for the screed.

8. Protection against theft and vandalism

Once work has been completed, the remote control unit for the screed can be collapsed and secured.



AB 340 Extending Screed

The **AB 340 Extending Screed** is optionally available for the SUPER 1003 with vibrators only (V version) or with tamper and vibrators (TV version). With this screed, rehabilitation jobs can be carried out very quickly and easily without ever compromising on quality.

The **unique VÖGELE** single-tube telescoping system enables the screed width to be adjusted up to 3.4m with millimetre precision and zero slack.

A **typical VÖGELE** feature also found in the AB 340 Extending Screed is its powerful electric heating system. This modern heating system quickly and uniformly heats the screed up to operating temperature, ensuring a smooth surface texture.

Excellent insulation of the screed plates reduces loss of heat to a minimum and ensures that heating the screed only takes a short time, even with the engine running at minimum rpm.

The SUPER 1003 screed system

AB 340

Pave widths

- » Infinitely variable range from 1.8m to 3.4m
- » Maximum pave width with bolt-on extensions:
 - » 3.9m (2 x 25cm)
- » Minimum pave width of 0.75m with the system for pave width reduction

Compacting systems

- » AB 340 V Extending Screed with vibrators
- » AB 340 TV Extending Screed with tamper and vibrators



AB 340

AB 340 with 25cm bolt-on extensions

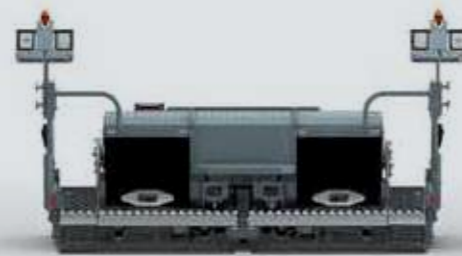

Easy transport
 *Even with bolt-on extensions and side plates fitted, the transport dimensions do not exceed 2.55m.

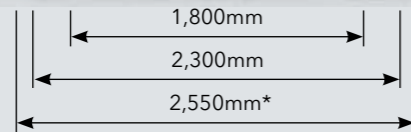

AB 340

Built up to maximum pave width



All the facts at a glance

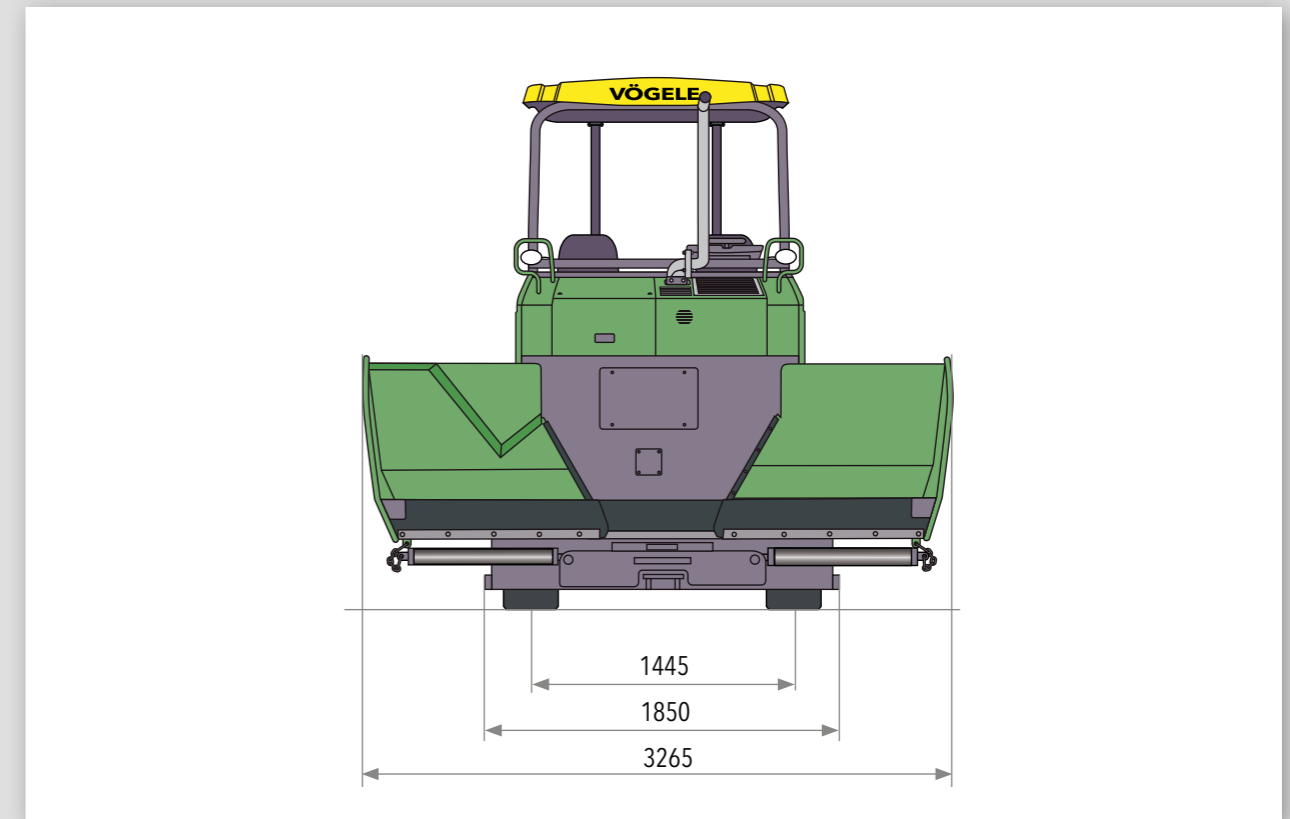
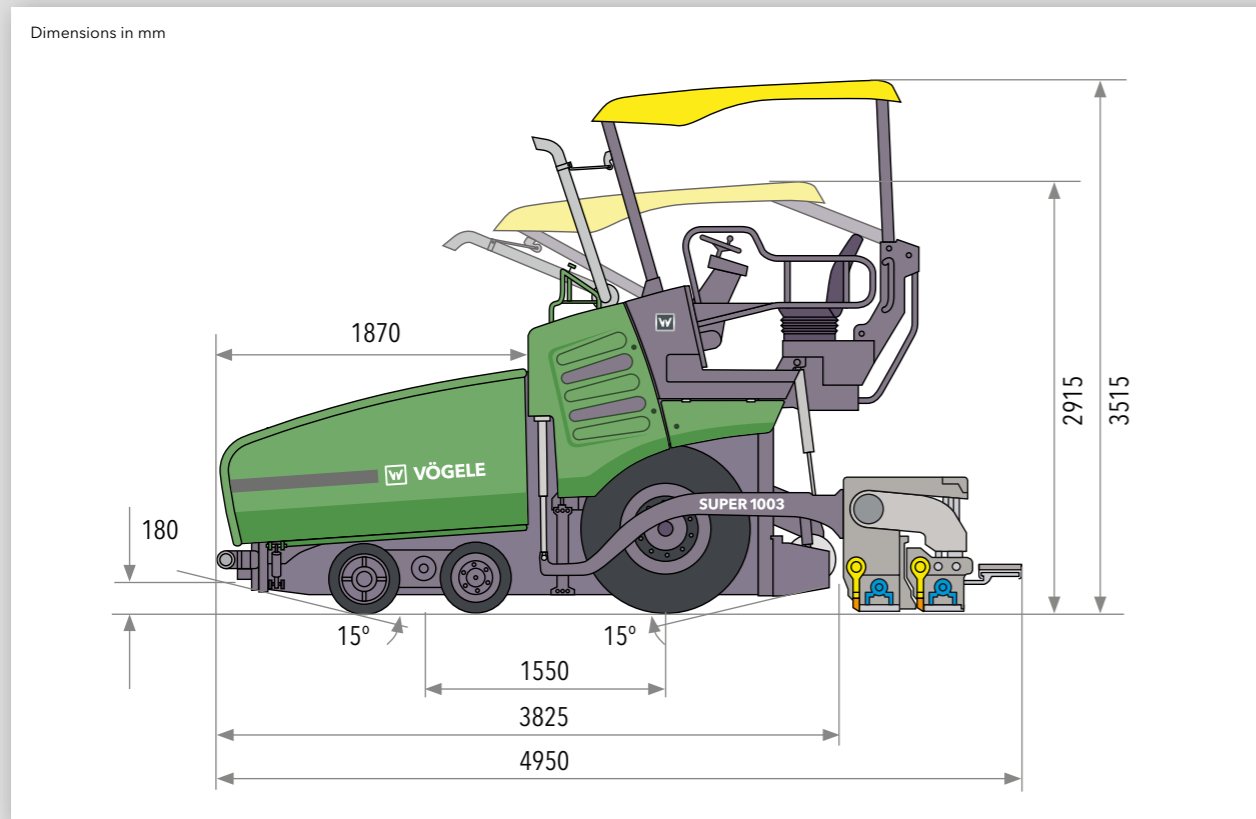

Power unit	
Engine	4-cylinder diesel engine
Manufacturer	Deutz
Type	TCD 3.6 L4
Output	
Nominal	55kW at 2,000rpm (according to DIN)
ECO mode	54kW at 1,600rpm
Exhaust emissions standards	EU Stage 3a, US EPA Tier 3
Fuel tank	105 litres

Undercarriage	
Front wheels	4, mounted on bogies
Tyre equipment	elastic solid rubber tyres
Tyre size	460/250 - 310mm
Rear wheels	2, pneumatic tyres or filled with water
Tyre size	365/80 R20
Drive	electronically controlled separate hydraulic drive provided for each wheel
Standard	2 rear wheels (6x2)
Option	2 rear and 2 front wheels (6x4)
Speeds	
Paving	up to 18m/min., infinitely variable
Transport	up to 20km/h, infinitely variable
Outside turning radius	min. 3.8m (with Pivot Steer)
Material hopper	
Hopper capacity	10t
Width	3,265mm
Feed height	570mm (bottom of receiving hopper)
Push-rollers	oscillating
Position	can be displaced forwards by 80mm

Conveyors and augers	
Conveyors	2, with replaceable feeder bars, direction of conveyor temporarily reversible
Drive	separate hydraulic drive provided for each conveyor
Speed	up to 22m/min., infinitely variable (manual or automatic)
Augers	2, with replaceable auger blades, auger rotation reversible
Diameter	300mm
Drive	separate hydraulic drive provided for each auger
Speed	up to 85rpm, infinitely variable (manual or automatic)
Auger height	
Standard	infinitely variable by 13cm, mechanical
Option	infinitely variable by 13cm, hydraulic

Screed		
AB 340	basic width	1.8 to 3.4m
	maximum width	3.9m
	with system for pave width reduction	0.75m
	reduction in width by cut-off shoes 2x52.5cm compacting systems	V, TV
Layer thickness	up to 15cm	
Screed heating	electric by heating rods	
Power supply	three-phase A.C. generator	
Dimensions (transport) and weights		
Length	paver with screed	
AB 340	4.95m	
Weights	paver with screed	
AB 340 V	9,800kg	
AB 340 TV	10,000kg	

Key: AB = Extending Screed V = with vibrators TV = with tamper and vibrators

Subject to technical changes.



Your VÖGELE QR Code
takes you to the
SUPER 1003 on our
homepage.



JOSEPH VÖGELE AG

Joseph-Vögele-Str. 1
67075 Ludwigshafen · Germany
www.voegele.info

T: +49 621 / 81 05 0
F: +49 621 / 81 05 461
marketing@voegele.info



® ERGOPLUS, InLine Pave, NAVITRONIC, NAVITRONIC Basic, NAVITRONIC Plus, NIVELTRONIC, NIVELTRONIC Plus, RoadScan, SprayJet, VÖGELE, VÖGELE PowerFeeder, PaveDock, PaveDock Assistant, AutoSet, AutoSet Plus, AutoSet Basic, ErgoBasic and VÖGELE-EcoPlus are registered Community Trademarks of JOSEPH VÖGELE AG, Ludwigshafen/Rhein, Germany. PCC is a registered German Trademark of JOSEPH VÖGELE AG, Ludwigshafen/Rhein, Germany. ERGOPLUS, NAVITRONIC Plus, NAVITRONIC BASIC, NIVELTRONIC Plus, SprayJet, VISION, VÖGELE, VÖGELE PowerFeeder, PaveDock, PaveDock Assistant, AutoSet, AutoSet Plus, AutoSet Basic and VÖGELE-EcoPlus are trademarks registered in the US Patent and Trademark Office to JOSEPH VÖGELE AG, Ludwigshafen/Rhein, Germany. Legally binding claims cannot be derived from written information or pictures contained in this brochure. We reserve the right to make technical or design alternations. Pictures may include optional extras.